

LED Operating Lamp

150F/400/3.1 (150F lamp complete with separate electronic power supply)

Focusable LED operating lamp

The 150F is a small operating lamp with the advantage of variable focusing. The 100,000 Lux light intensity provides colour rendering indexes R_a above 95 and R_9 (red) above 90. This enables a surgeon to clearly determine the smallest nuances in wound tissue colour and helps reduce eye fatigue. The LED technology used, ensures greatly reduced operating temperatures compared with traditional halogen bulbs, meaning temperature rise at the operators head area is almost undetectable.

The multiple faceted lenses provide a homogenous light field. This light field can be easily focused by turning the sterilisable handle, enabling illumination of the deepest wound. Both the power, and light intensity control are operated from the lamp head.

Features

- > Light intensity at 1 meter distance, 100,000 Lux
- > Dimmable
- > Colour rendering index R_a 95
- > Colour rendering index R_9 90
- > Focusable light field size is 14-25 cm
- > Colour temperature is 4300 Kelvin
- > Electronic light intensity control at lamp head, 50-100%
- > Temperature increase at head area of 0.5 °C
- > Total power consumption, 35W
- > Light source, 24 LED's
- > Life span of over 40,000 hours
- > Diameter of lamp head is 38 cm





Technical Specifications

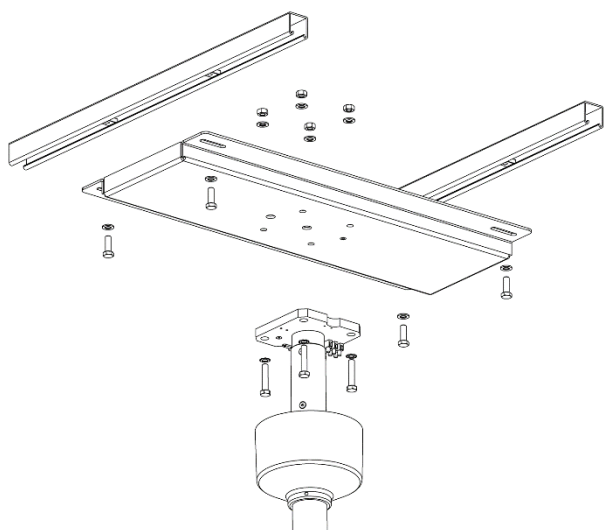
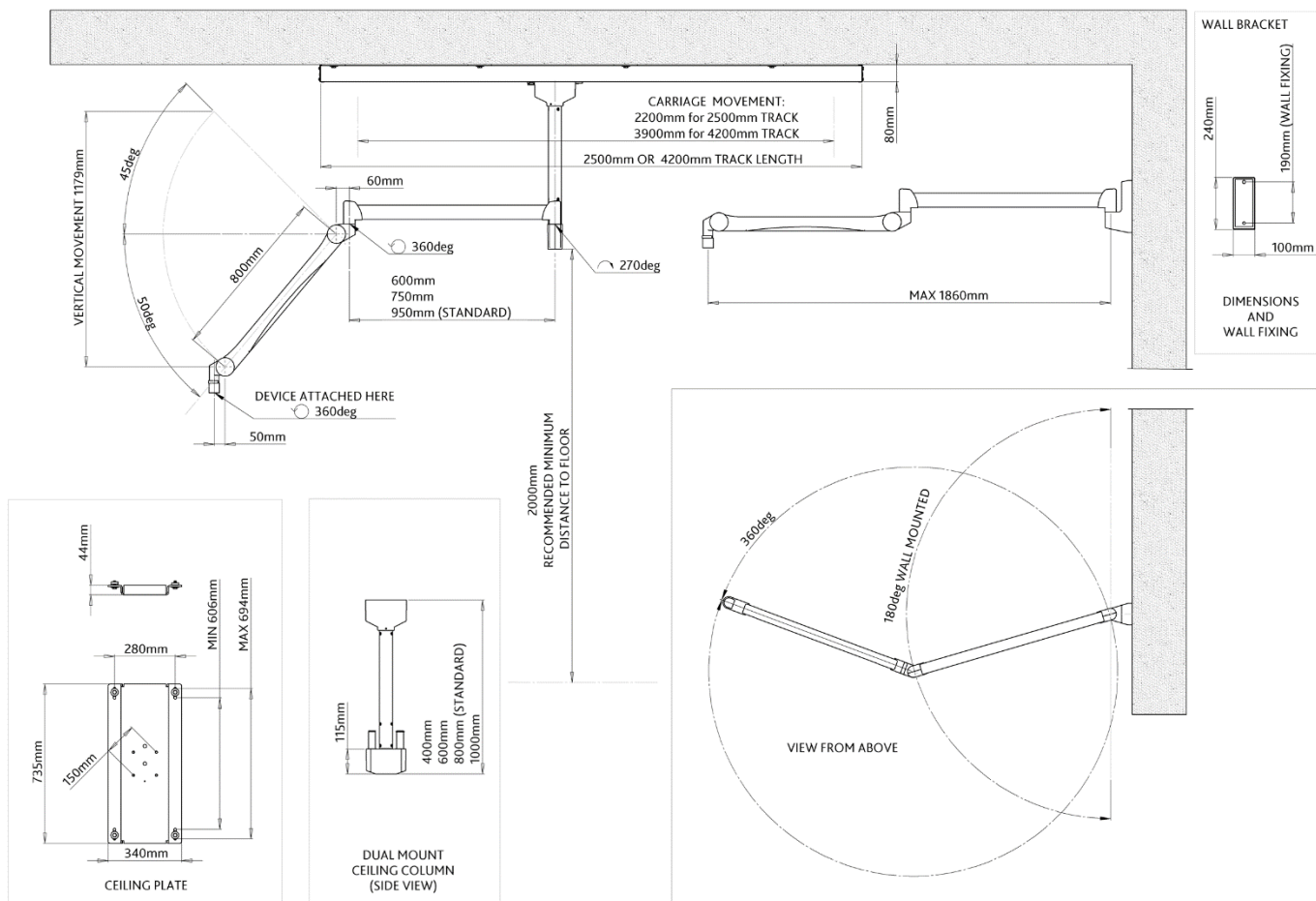

Optional installation aid: Ceiling plate #300/P/004 (shown with ceiling rails and ceiling column)

Weights

- LED 150F **2.4 kg**
- Dual mount ceiling column (80 cm) **11 kg**
- Suspension arm **9 kg**
- Wall bracket **2 kg**
- Ceiling track **50 kg**
- Installation aid - Anchorage plate (#300/P/004) **15 kg**