

LED Examination Lamp

300/CL-LED130F (LED 130F lamp with power supply, suspension arm and ceiling column)

Focusable LED examination lamp

The LED 130F is a small examination lamp with the advantage of variable focusing. The 70,000 Lux light intensity provides colour rendering index R_a 95. The multiple faceted lenses provide a homogenous light field which can be easily focused by turning the sterilisable handle.

Both power and light intensity are controlled from the lamp head. The LED technology used, ensures greatly reduced operating temperatures compared with traditional halogen bulbs, meaning temperature rise at the operators head area is almost undetectable.

Features

- > Light intensity at 1 metre: 70,000 Lux
- > Electronic light intensity control
at lamp head: 50% to 100%
- > Colour rendering index R_a 95
- > Focusable light field size: 14cm to 25 cm
- > Colour temperature: 4300 Kelvin
- > Temperature increase at head area: 0.5 °C
- > Total power consumption: 28W
- > Light source: 19 LED's
- > Life span of over 50,000 hours
- > Diameter of lamp head: 33 cm
- > Detachable sterilizable handle included



Model 300/CL-LED130F is supplied with a two part suspension arm allowing versatile movement, which is mounted onto an 80 cm ceiling column (over lengths available). The column can be attached to a load bearing or suspended ceiling (different installation aids are available to suit differing site conditions – see over). Alternatively, the column can be directly attached to the movable carriage of a 2.5 m or 4.2 m ceiling track (available separately) with lamp cables contained and managed within a separately supplied flexible energy chain. These options enable the complete assembly to move into and out of the working area as required. The spare pivot of the ceiling column can carry a Kenex radiation shield (available separately).



Technical Specifications

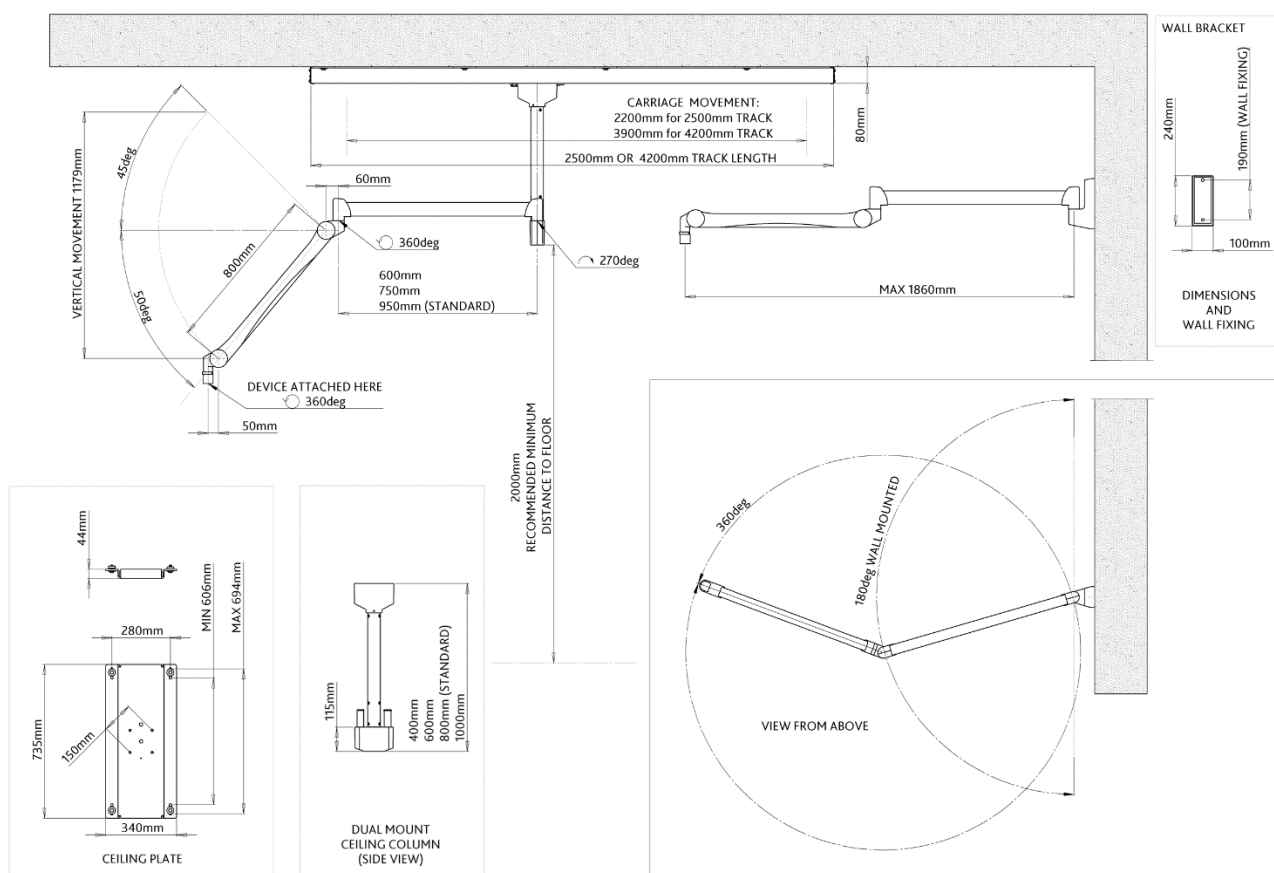

Equipment weights & part numbers

Included:

- Power supply in housing
- LED 130F lamp head: **2 kg** (approximately)
- Suspension arm: **9 kg**
- 80 cm dual mount ceiling column: **12.8 kg**

Optional equipment:

- Dual mount ceiling column:
 - 40 cm (#300/COLUMN/40): **10.2 kg**
 - 60 cm (#300/COLUMN/60): **11.5 kg**
 - 100 cm (#300/COLUMN/100): **14.1 kg**
- Ceiling track & carriage:
 - 2.5 m (#3001/TC/250): **50 kg**
 - 4.2 m (#3001/TC/420): **72 kg**
- Track cable management:
 - 2.5 m (#3001/TC/250/EC)
 - 4.2 m (#3001/TC/420/EC)
- Additional track carriage:
 - For use in 2.5 m or 4.2 m track (#3001/3.25): **4.6 kg**

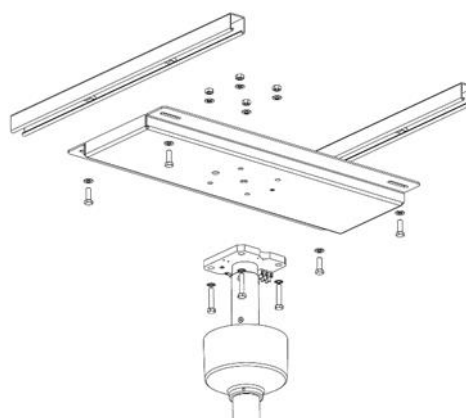

Optional installation aids:

- Ceiling column anchorage plate #300/P/004 (shown above attaching to ceiling rails with separately supplied ceiling column)
- Ceiling void installation kits #300/P/012 & #300/P/014